

## Water Storage Tanks

### Open Top Tank Erection Instructions

Including details of PVC and Steel Roof Options



#### Notes:

1. Read these instructions before starting assembly.
2. Leave these instructions with the end user.
3. This is a load bearing structure. Ensure that the tank is assembled in exact compliance with the instructions.
4. Ensure that galvanised components are stored in a dry building to prevent the formation of white rust.
5. Ensure that the wall sheets are fitted in the correct position with the thickest at the bottom. Check the positions of sheets by comparing the code letter with the enclosed chart.
6. All hardware quantities are carefully checked before despatch. Before claiming shortages please check the tank is correctly assembled.
7. Under no circumstances should the tanks be extended without reference to RNT Tanks & Silos Ltd.
8. All tanks less than 2m in height above ground level should be protected from entry by fitting a roof or a suitable safety fence.
9. Standard tanks are designed for above ground installation only.

#### IF IN DOUBT ASK!

Always quote 207453 in reference to this order.

Top Ring	42/0.8/2	M10
Third Rind	42/1.0/2	M10
Second Ring	42/1.0/3	M10
Bottom Ring	42/1.2/3	M10

**◆ Erecting the Steel Walls ◆**

Corrugated sheet steel tanks must be regarded as flexible, 'live', structures. Small relative movements of the order of 1 to 10mm between the wall and base are almost inevitable between the full and empty condition.

Hydrostatic forces tend to 'round-up' a non-circular shape so any tank assembled out-of-round may exhibit excessive movement.

**To aid good circularity, two circles at radii Rmax and Rmin should be scribed or clearly marked on the base before erecting the tank within these lines.**

**We again emphasise the importance of building a round tank above scribed line!**

Number of sheets/ring	Diameters		Radii	
	Nominal - Dnom feet	Calculated - DC m	In Rmin - mm	Out Rmax - mm
1	3	.900	446	476
2	6	1.843	903	941
3	9	2.765	1,369	1,396
4	12	3.687	1,825	1,862
5	15	4.608	2,281	2,327
6	18	5.530	2,737	2,793
7	21	6.452	3,194	3,258
8	24	7.374	3,650	3,724
9	27	8.295	4,106	4,189
10	30	9.217	4,562	4,655
11	33	10.139	5,019	5,120
12	36	11.060	5,475	5,585
13	39	11.982	5,931	6,051
14	42	12.904	6,387	6,516
15	45	13.826	6,844	6,982
16	48	14.747	7,300	7,447
17	51	15.669	7,756	7,913
18	54	16.588	8,212	8,378
19	57	17.512	8,669	8,844
20	60	18.434	9,125	9,309
21	63	19.356	9,581	9,775
22	66	20.277	10,037	10,240
23	69	21.199	10,494	10,706
24	72	22.121	10,950	11,171
25	75	23.043	11,406	11,636
26	78	23.964	11,862	12,102
27	81	24.886	12,318	12,567
28	84	25.808	12,775	13,033
29	87	26.729	13,231	13,498
30	90	27.651	13,687	13,964
31	93	28.573	14,143	14,429
32	96	29.494	14,600	14,895
33	99	30.416	15,056	15,360

## ◆ Precautions to be Taken by Erectors ◆

### **WARNING !!**

**The erection of RNT Tanks & Silos' water tanks and roofs requires certain skills and training and should not be undertaken by people lacking building, lifting and constructional competence.**

#### **1. UNLOADING:**

Water tank components are loaded on the lorry by forklift trucks in packs weighing up to 2,000 kgs. If suitable lifting equipment is not available the packs must be split and unloaded by hand. The weight of individual components is unlikely to exceed 50 kgs.

#### **2. HANDLING:**

The manufacturing process may leave sharp edges. Gloves must be worn when cutting packing bands.

#### **3. CLIMBING:**

For protection or simply as part of the manufacturing process, sheets may be covered with a film of oil making the surface very slippery. Do not walk on sheet components or climb on sloping roofs. Ladders must be securely fixed or lashed.

#### **4. WIND:**

Great care must be taken when working in windy conditions. If in doubt, assembly operations must be suspended until the return of calmer conditions. This would apply especially in the later stages of erecting higher tanks. Partially erected tanks must be lashed securely when left unattended. Loose sheet components are potentially dangerous in high winds and must be stored under cover.

#### **5. BOLTED CONNECTIONS:**

The instruction book and packing notes will indicate the correct bolt type, length and diameter for every position. These instructions must be adhered to, especially where high tensile grades are indicated. The holes must be lined up and the bolts inserted by hand. The performance of bolts when the threads are damaged due to hammering or screwing through will be compromised and must be replaced. It is most important that bolted components are checked for correct alignment after tightening.

#### **6. ROOF ASSEMBLY:**

When completely erected much of the strength of the tank roof is derived from its forming a structural cone. During assembly great care must be taken to avoid overstressing the components and no weight may be applied to the roof panels without additional support from below. When fitting the bolts into the last sheet a ladder or crawling board must be used to spread the erector's weight.

#### **7. FOUNDATION BOLTS:**

May be cast in or drilled in-situ. Projecting bolt heads in the base create a real hazard during erection and must be protected. When the walls are completed the tank must be carefully checked to be absolutely round and the anchor brackets fitted so the 'tie' is sitting in contact with the base. Do not pull the anchor brackets down on to an uneven base slab to the point where the tank wall deflects. In this situation packing shims must be inserted into the gap between the bracket and concrete surface.

#### **8. WORKING ENVIRONMENT:**

New galvanised components are very bright. Eye protection may be necessary in sunny conditions. The enclosed nature of tanks can result in high noise levels from power tools, ear protection must be worn. Hard hats with chin straps and safety boots must be worn. A safety harness must be used and securely fastened when working on tank roofs or enclosed spaces as defined by the Confined Space Regulations. The working area around the tanks in the course of construction must be fenced off to prevent unauthorised access by personnel or traffic. Pits and trenches must be covered.

#### **9. POWER LINES:**

Long metal components and aluminium ladders must be handled with great care in vicinity of overhead power lines. There can be a flash-over hazard even when normal safe working clearances are used.

**Erection construction must at all times comply with the Health and Safety at Work Act 1974/1992 and, where appropriate, the requirements of the Construction (Design and Management) Regulations 1994 (CDM).**

## ◆ Legionnaires Disease ◆

Legionella bacteria are widespread in natural sources of water including rivers, streams and ponds and may even be found in soil. They are also found in many re-circulating and hot and cold water systems.

Infection is caused by people breathing in water droplets with legionella bacteria, which leads to a type of pneumonia known as Legionnaires Disease.

Since legionella is widespread in the environment, it cannot be prevented from entering water systems. However, the risk of an outbreak developing can be reduced by taking the following precautions where appropriate:-

- (a) Minimisation of the release of water spray.
- (b) Avoidance of water temperatures and conditions that favour the proliferation legionella and other micro-organisms.
- (c) Avoidance of water stagnation.
- (d) Avoidance of the use of materials that harbour bacteria and other micro-organisms or provide nutrients for microbial growth.
- (e) Maintenance of the cleanliness of the system and the water in it.
- (f) Use of water treatment techniques.
- (g) Action to ensure the correct and safe operation and maintenance of the water system and plant.

Experience shows that the conditions presenting a risk of legionellosis include plant and systems containing water which is likely to exceed 20°C and which may release a spray or aerosol (e.g. the open cold water storage tank serving sprinkler systems).

Measures need to be implemented to prevent the risk of legionella infections.

### **Further information:-**

The Approved Code of Practice, the Health and Safety Executive has published a booklet, 'The Control of legionellosis' including 'Legionnaires Disease'. This contains technical advice on assessing and minimising the risk from exposure to legionella. It reflects the progress of research and experience into the disease that has occurred since then. A leaflet is produced by the Health and Safety Executive. Prices and free publications are available by mail order from:-

[www.hse.gov.uk/pubns/books/18.htm](http://www.hse.gov.uk/pubns/books/18.htm)  
[www.hse.gov.uk/pubns/indg458.htm](http://www.hse.gov.uk/pubns/indg458.htm)

## ◆ Site Preparation ◆

### Concrete Base

In order to comply with Ministry of Agriculture EU Regulations, it is necessary to erect the tank on a concrete base.

Dependent upon local soil conditions and size of slab, it may be necessary to insert steel reinforcement in the base of the slab.

The concrete base must have level and relatively smooth surface and extend at least 315mm greater than the outside diameter of the tank.

Up to 1,525mm high tanks, concrete thickness should be 100mm minimum  
Above 2,285mm high tanks, concrete thickness should be 150mm minimum

### Earth Base (not recommended)

The tank must be mounted on firm ground, free from flint, stones, roots and any rubbish likely to perforate the liner. It must be appreciated that future root growth may puncture the liner.

The ground should be consolidated and compacted to a reasonable distance beyond the tank base and the area occupied by the tank must be level and smooth.

### **NOTE:**

Whether the base is concrete or soil, it must be capable of supporting the weight of the tank filled with water.

Anchor bracket must be fitted to all water tanks.

## ◆ Erection ◆

### Tank Erection

Sweep the base clean and ensure that there are no projections that could damage the liner.

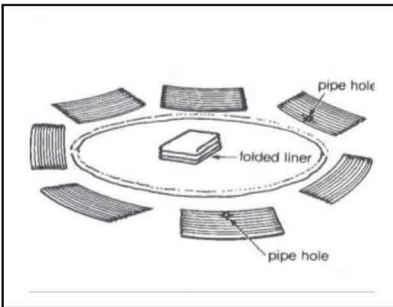

Place liner on the ground in centre of circle. Ensure that no oil or petroleum is in contact with liner (which causes damage as well as contamination).

The thickest panel is used at the base of the tank and the thinnest at the top, the sheets are normally packed on the pallet in the order they should be assembled, for example the bottom ring of sheets will be on top of the pallet.

Each sheet is additionally marked in the top left hand corner with an adhesive label. Giving its Diameter, thickness and whether double or triple punched holes are on the upright join.

21/0.8/2 denotes a 21' 0.8mm sheet with a row of double holes each end.

Mark two circles on the base and build the tank over them to ensure the structure is 'round' (*see page 2 for measurements*).

Loosely bolt the bottom layer of sheets together to form a circle. Use a podger to ensure that the bolt holes line up. Bolt heads **must** be inside the tank with a plain washer and nut on the outside. Place the pre-drilled panel for outlet fitting, if any, in correct location.

### Hardware

M10 hardware is supplied for the standard range of tanks but for larger or higher tanks M12 diameter bolts, nuts and washers may be required. Check with the Packing List (attached to Advice Note). Always use the largest diameter bolts for the bottom rings of the tank.

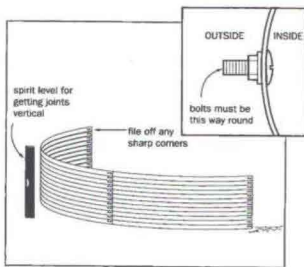

### **Base Ring**

Work in a clockwise direction, placing each consecutive sheet on the inside of the preceding one to complete the circle, the end of the last sheet being secured to the outside of the first sheet. If the tank is supplied with pre-drilled inlet/outlet holes make sure they are assembled in the correct position.

Fit anchor brackets using longer bolts supplied (see page 7).

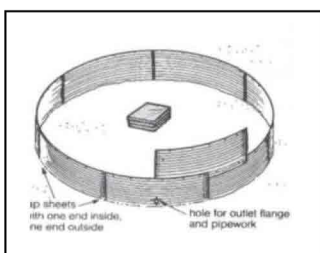

### **Second and Subsequent Rings**

Each is fitted outside the ring below to shed rain. Proceed as for base ring and **ensure that the correct steel thickness is used**. Stagger vertical joints and tighten all bolts securely when erection is completed.

### **Inspect Inside of Tank**

1. Is there a bolt in every punched hole except for the top horizontal line of holes? **THIS IS IMPORTANT AS THEY HOLD THE HOOP TENSION OF THE STORED LIQUID.**
2. Ensure that **all screw heads are inside the tank.**
3. Any damaged corners and/or distorted edges of the corrugated sheets must be straightened back to their original profile to prevent damage to the liner.
4. Fit the anchor brackets to the outside of the tank before fitting the Butyl liner.
5. We recommend bolt heads be covered with cloth tape.

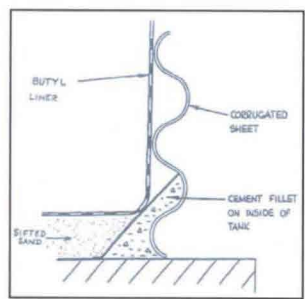

### **Sand Layer**

From a 5:1 dry cement mix, a 75mm high flaunching must be provided around the inside circumference of the tank base to ensure retention of the sand and the rubber liner.

It is essential to place a 50mm layer of sand over the concrete base.

Make sure the tank is still round before bolting down to the concrete base. If a galvanised roof has been ordered with the tank, make sure the M10 x 40 long bolts have been fitted for the roof securing brackets before the liner is fitted over the wall.

### **Fillet details**

Check the Roof Assembly Book for the correct position of the bolts.



### **Fitting the Liner**

1. Fit the 12mm capping around the top edge of the tank.
2. Hang the Butyl liner over the side of the tank leaving approximately a 300mm flap.
3. Check that the liner has no vertical or diagonal crease in the wall and that the base seam fits exactly into the corner of the cement fillets. **CREASES IN THE LINER ALWAYS SHOW EVEN WHEN REMOVED FROM THE TANK AND THIS INVALIDATES THE WARRANTY.**

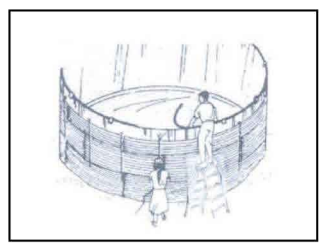

4. Trap it with the 25mm capping.
5. Fit the spring clips over the external capping at regular intervals (approx. 900mm).
6. Included in the kit is a length of wire and a strainer to act as a collar and secure the 300mm overhang around the circumference of the tank to prevent the liner creeping back under the capping over the years. This wire collar should be slightly strained to prevent cutting into the liner whilst tightening.

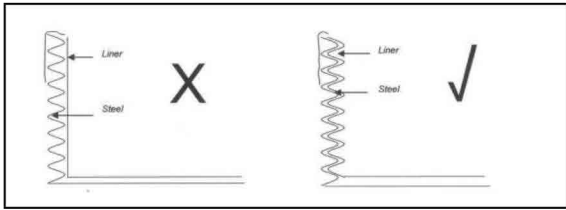
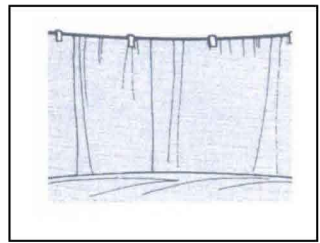

◆ **Securing the Galvanised Tank Wall to Base** ◆

Fix the anchor brackets provided on the outside of the tank, one at each end joint in the galvanised wall, with roofing bolts. All bolt heads to be **inside** the tank. If the bolt heads are damaged during fixing, all burrs must be removed and the smooth surfaces restored.

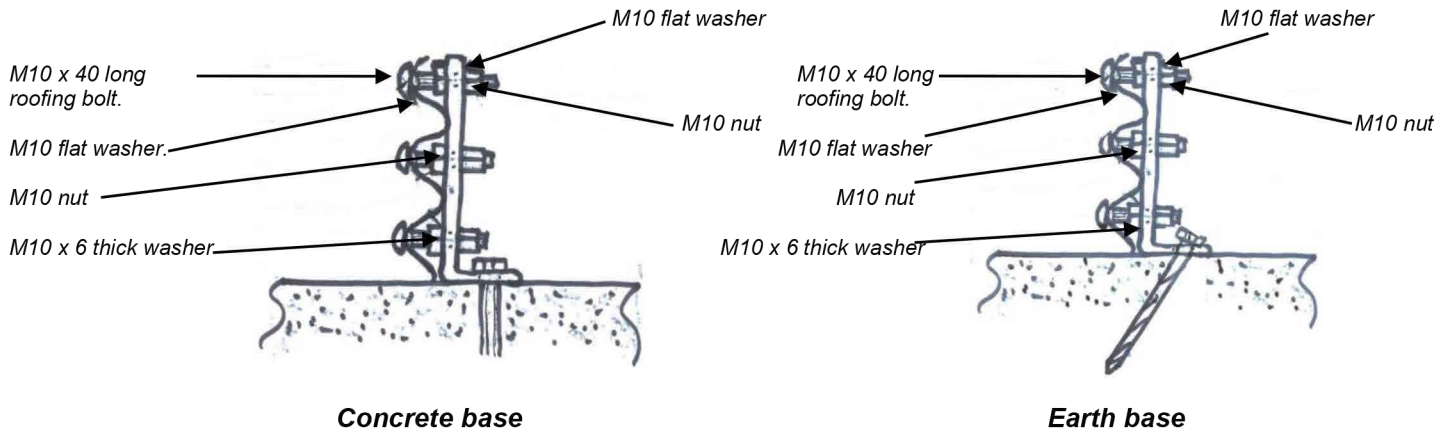

Drive the ground securing stakes to secure the feet of the brackets to an earth base. The stakes should be driven at an angle towards the inside of the tank.

◆ **Instructions for Fitting the Pump Connection** ◆

**Not supplied as standard only to order**

If a pipe connection through the side of the tank is being used (as against a suction hose over the top of the tank), the fitting of this should be done before the liner is fixed permanently in position and should proceed as follows:-

Make sure that the sheet containing the hole, through which the connection is to be fitted, is near the pipe connection. This must be taken into account when assembling the tank.

Carefully position the liner. Tap around the edge of the threaded pipe with a hammer until round hole has been cut and the liner slips over the pipe and up to the steel flange. Assemble as shown below.

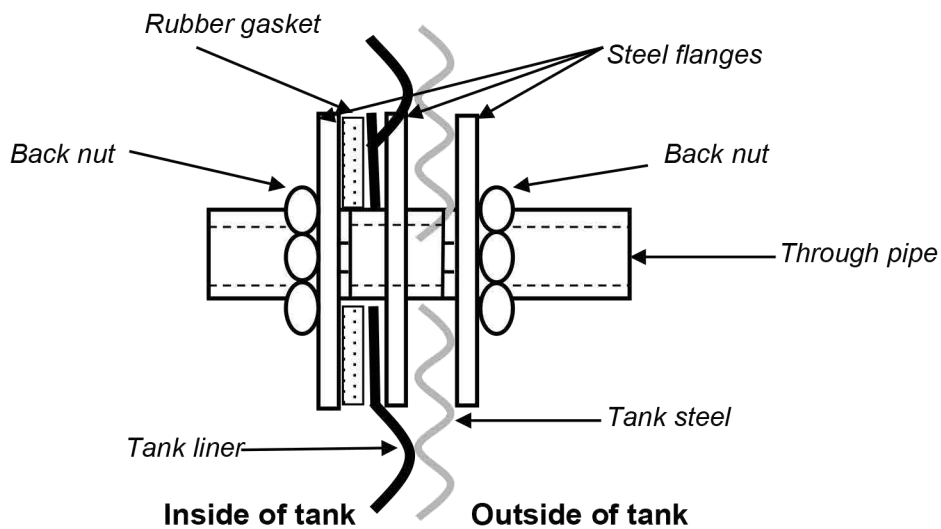

◆ Water Tanks: 50mm thick sand layer in the bottom of the tank under liner ◆

Tank diameter		Weight	Cubic metres	Barrow loads
Nominal feet	Metres	Tonne		(6 cubic feet)
9'	2.765	0.5	0.3	2
12'	3.687	0.8	0.5	3
15'	4.608	1.3	0.9	5
18'	5.530	2.0	1.2	7
21'	6.425	2.6	1.6	10
24'	7.374	3.5	2.1	13
27'	8.295	4.3	2.7	16
30'	9.217	5.3	3.3	20
33'	10.139	6.5	4.0	24
36'	11.060	7.7	4.8	28
39'	11.982	9.0	5.6	33
42'	12.904	10.5	6.5	38
45'	13.826	12.4	7.5	44
48'	14.747	14.0	8.5	50

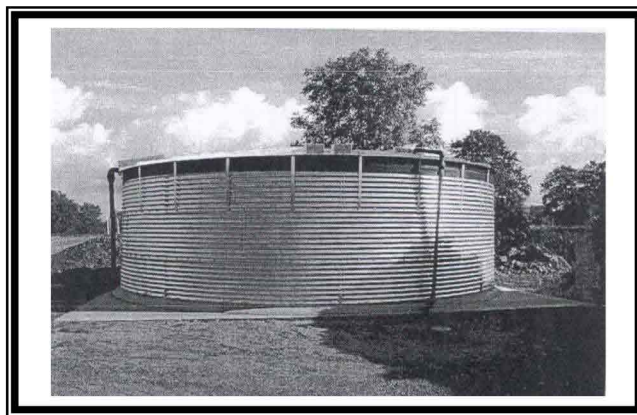

**LOOK**

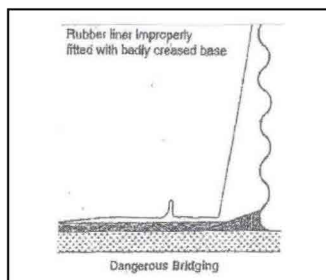

Even if the tank has been left over the lunch hour a gust of wind may have moved the wall-to-base seam of the liner away from the tank side. This will not show up from a cursory inspection and it is essential that the erector gets inside the tank to check that the liner is properly positioned by feeling the steel through the liner **WHILE THE FIRST 50 - 75mm OF WATER IS RUN IN.**

150mm of water on the base will lock the liner in position and wind is then unable to disarrange it. Failure to position the liner correctly will cause dangerous bridging as illustrated.

**NOTE:**

If the tank is to be fitted with a galvanised cover make sure that you check the top of the tank for roundness before flaunching the inside circumference of the wall to the base. Although the base of the tank may be built within the base scribed lines, small amounts of base un-evenness is enough to oval the top of the tank. Adjust the anchor bracket bolts holding the tank to the concrete base. Where the tank wall leans outwards (giving an oversize diameter) loosen the anchor bolt and shim upwards. Elsewhere, and especially where the tank wall leans inwards (diameter undersize), tighten the anchor bracket fixing bolts so as to force the wall downwards. This must be done before flaunching, sand infilling and liner fitment.



**◆ Metric Fastener Torque Settings ◆**

In order to satisfy the requirements of DIN18800-1:1990 and DIN18914:1985, all joints are classed as shear/bolt hold bearing pressure connections (SL connections). However, for connections in tension bolts/nuts should be preloaded by a minimum of 0.5Fv (50% proof load) to help improve their fatigue strength in service. Thus following good practice, all joints will adhere to this premise and the tightening torque shall be based on those published in DIN18914; table 1, using tolerances of +/-20%. This ensures that the minimum 50% proof load is achieved without breaching the maximum 100% limit.

Many variables will affect the tightening torque of a given screwed connection. For example, weather, tooling, fastener finish, which in turn will affect the amount of friction present in a connection. In accordance with this variability, erectors should use the target torque values stated below within the tolerance values so as to achieve the required inspection standards.

	<b>Applied torque (Mv); Grade 8.8 hardware</b>	
	<b>No friction</b>	<b>Include friction</b>
Nominal bolt diameter	Typical application: wet, oiled, nut runner, high speed erection	Typical application: dry, plated, torque wrench, inspection
(Mxx) mm	Target torque Nm	Target torque Nm
10	30	34
12	88.01	101.21

**NOTE:** This table is specific to the fastener combination used in RNT Tanks & Silos construction.